

Dual-Synchronous, Step-Down Controller with Out-of-Audio™ Operation and 100-mA LDOs for Notebook System Power

FEATURES

- Wide Input Voltage Range: 5.5 V to 28 V
- Output Voltage Range: 2 V to 5.5 V
- Built-in 100-mA 5-V/3.3-V LDO with Switches
- Built-in 1% 2-V Reference Output
- With/Without Out-of-Audio™ Mode Selectable Light Load and PWM only Operation
- Internal 1.6-ms Voltage Servo Softstart
- Adaptive On-Time Control Architecture with Four Selectable Frequency Setting
- 4500 ppm/°C $R_{DS(on)}$ Current Sensing
- Built-In Output Discharge
- Power Good Output
- Built-in OVP/UVP/OCF
- Thermal Shutdown (Non-latch)
- QFN24 (RGE)

APPLICATIONS

- Notebook Computers
- I/O Supplies
- System Power Supplies

DESCRIPTION

The TPS51125 is a cost effective, dual-synchronous buck controller targeted for notebook system power supply solutions. It provides 5-V and 3.3-V LDOs and requires few external components. The 270-kHz VCLK output can be used to drive an external charge pump, generating gate drive voltage for the load switches without reducing the main converter's efficiency. The TPS51125 supports high efficiency, fast transient response and provides a combined power-good signal. Out-of-Audio™ mode light-load operation enables low acoustic noise at much higher efficiency than conventional forced PWM operation. Adaptive on-time D-CAP™ control provides convenient and efficient operation. The part operates with supply input voltages ranging from 5.5 V to 28 V and supports output voltages from 2 V to 5.5 V. The TPS51125 is available in a 24-pin QFN package and is specified from -40°C to 85°C ambient temperature range.

Typical Application Diagram

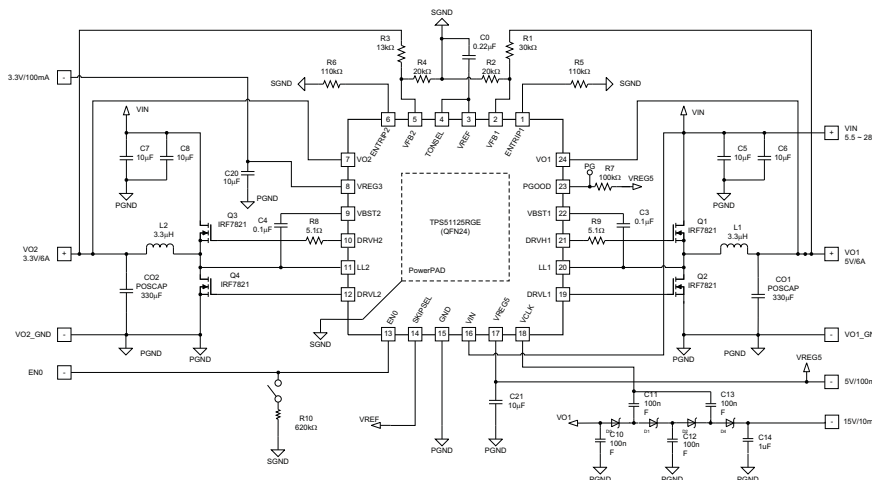

Please be aware that an important notice concerning availability, standard warranty, and use in critical applications of Texas Instruments semiconductor products and disclaimers thereto appears at the end of this data sheet.

Out-of-Audio, D-CAP are trademarks of Texas Instruments.

ORDERING INFORMATION

T _A	PACKAGE	PART NUMBER	PINS	OUTPUT SUPPLY	MIN QUANTITY	ECO PLAN
-40°C to 85°C	Plastic Quad Flat Pack (QFN)	TPS51125RGET	24	Tape -and-Reel	250	Green (RoHS and no Sb/Br)
		TPS51125RGER		Tape -and-Reel	3000	

ABSOLUTE MAXIMUM RATINGS⁽¹⁾

over operating free-air temperature range (unless otherwise noted)

PARAMETER		VALUE	UNIT
Input voltage range ⁽¹⁾	VBST1, VBST2	-0.3 to 36	V
	VIN	-0.3 to 30	
	LL1, LL2	-2.0 to 30	
	VBST1, VBST2 ⁽²⁾	-0.3 to 6	
	EN0, ENTRIP1, ENTRIP2, VFB1, VFB2, VO1, VO2, TONSEL, SKIPSEL	-0.3 to 6	
Output voltage range ⁽¹⁾	DRVH1, DRVH2	-1.0 to 36	V
	DRVH1, DRVH2 ⁽²⁾	-0.3 to 6	
	PGOOD, VCLK, VREG3, VREG5, VREF, DRVL1, DRVL2	-0.3 to 6	
T _J	Junction temperature range	-40 to 125	°C
T _{stg}	Storage temperature	-55 to 150	

(1) Stresses beyond those listed under "absolute maximum ratings" may cause permanent damage to the device. These are stress ratings only and functional operation of the device at these or any other conditions beyond those indicated under "recommended operating conditions" is not implied. Exposure to absolute-maximum-rated conditions for extended periods may affect device reliability.

(2) Voltage values are with respect to the corresponding LLx terminal.

DISSIPATION RATINGS

2-oz. trace and copper pad with solder.

PACKAGE	T _A < 25°C POWER RATING	DERATING FACTOR ABOVE T _A = 25°C	T _A = 85°C POWER RATING
24 pin RGE ⁽¹⁾	1.85 W	18.5 mW/°C	0.74 W

(1) Enhanced thermal conductance by 3x3 thermal vias beneath thermal pad.

RECOMMENDED OPERATING CONDITIONS

over operating free-air temperature range (unless otherwise noted)

PARAMETER		MIN	TYP	MAX	UNIT
Supply voltage	VIN	5.5		28	V
Input voltage range	VBST1, VBST2	-0.1		34	
	VBST1, VBST2 (wrt LLx)	-0.1		5.5	
	EN0, ENTRIP1, ENTRIP2, VFB1, VFB2, VO1, VO2, TONSEL, SKIPSEL	-0.1		5.5	
Output voltage range	DRVH1, DRVH2	-0.8		34	
	DRVH1, DRVH2 (wrt LLx)	-0.1		5.5	
	LL1, LL2	-1.8		28	
	VREF, VREG3, VREG5	-0.1		5.5	
	PGOOD, VCLK, DRVL1, DRVL2	-0.1		5.5	
T _A	Operating free-air temperature	-40		85	°C

ELECTRICAL CHARACTERISTICS

over operating free-air temperature range, VIN = 12 V (unless otherwise noted)

PARAMETER		CONDITIONS	MIN	TYP	MAX	UNIT
Supply Current						
I _{VIN1}	VIN supply current1	VIN current, T _A = 25°C, no load, VO1 = 0 V, VO2 = 0 V, EN0=open, ENTRIPx = 5 V, VFB1 = VFB2 = 2.05 V		0.55	1	mA
I _{VIN2}	VIN supply current2	VIN current, T _A = 25°C, no load, VO1 = 5 V, VO2 = 3.3 V, EN0=open, ENTRIPx = 5 V, VFB1 = VFB2 = 2.05 V		4	6.5	μA
I _{VO1}	VO1 current	VO1 current, T _A = 25°C, no load, VO1 = 5 V, VO2 = 3.3 V, EN0=open, ENTRIPx = 5 V, VFB1 = VFB2 = 2.05 V		0.8	1.5	mA
I _{VO2}	VO2 current	VO2 current, T _A = 25°C, no load, VO1 = 5 V, VO2 = 3.3 V, EN0=open, ENTRIPx = 5 V, VFB1 = VFB2 = 2.05 V		12	100	μA
I _{VINSTBY}	VIN standby current	VIN current, T _A = 25°C, no load, EN0 = 1.2 V, ENTRIPx = 0 V		95	250	
I _{VINSDN}	VIN shutdown current	VIN current, T _A = 25°C, no load, EN0 = ENTRIPx = 0 V		10	25	
VREF Output						
V _{VREF}	VREF output voltage	I _{VREF} = 0 A	1.98	2.00	2.02	V
		-5 μA < I _{VREF} < 100 μA	1.97	2.00	2.03	
VREG5 Output						
V _{VREG5}	VREG5 output voltage	VO1 = 0 V, I _{VREG5} < 100 mA, T _A = 25°C	4.8	5	5.2	V
		VO1 = 0 V, I _{VREG5} < 100 mA, 6.5 V < VIN < 28 V	4.75	5	5.25	
		VO1 = 0 V, I _{VREG5} < 50 mA, 5.5 V < VIN < 28 V	4.75	5	5.25	
I _{VREG5}	VREG5 output current	VO1 = 0 V, VREG5 = 4.5 V	100	175	250	mA
V _{TH5VSW}	Switch over threshold	Turns on	4.55	4.7	4.85	V
		Hysteresis	0.15	0.25	0.3	
R _{5VSW}	5 V SW R _{ON}	VO1 = 5 V, I _{VREG5} = 100 mA		1	3	Ω
VREG3 Output						
V _{VREG3}	VREG3 output voltage	VO2 = 0 V, I _{VREG3} < 100 mA, T _A = 25°C	3.2	3.33	3.46	V
		VO2 = 0 V, I _{VREG3} < 100 mA, 6.5 V < VIN < 28 V	3.13	3.33	3.5	
		VO2 = 0 V, I _{VREG3} < 50 mA, 5.5 V < VIN < 28 V	3.13	3.33	3.5	
I _{VREG3}	VREG3 output current	VO2 = 0 V, VREG3 = 3 V	100	175	250	mA
V _{TH3VSW}	Switch over threshold	Turns on	3.05	3.15	3.25	V
		Hysteresis	0.1	0.2	0.25	
R _{3VSW}	3 V SW R _{ON}	VO2 = 3.3 V, I _{VREG3} = 100 mA		1.5	4	Ω
Internal Reference Voltage						
V _{IREF}	Internal reference voltage	I _{VREF} = 0 A, beginning of ON state	1.95	1.98	2.01	V
V _{VFB}	VFB regulation voltage	FB voltage, I _{VREF} = 0 A, skip mode	1.98	2.01	2.04	
		FB voltage, I _{VREF} = 0 A, OOA mode ⁽¹⁾	2.00	2.035	2.07	
		FB voltage, I _{VREF} = 0 A, continuous conduction ⁽¹⁾		2.00		
I _{VFB}	VFB input current	VFBx = 2.0 V, T _A = 25°C	-20		20	nA

(1) Ensured by design. Not production tested.

ELECTRICAL CHARACTERISTICS (continued)

over operating free-air temperature range, VIN = 12 V (unless otherwise noted)

PARAMETER		CONDITIONS	MIN	TYP	MAX	UNIT
V_{OUT} Discharge						
I _{Dischg}	V _{OUT} discharge current	ENTRIPx = 0 V, VOx = 0.5 V	10	60		mA
Output Drivers						
R _{DRVH}	DRVH resistance	Source, V _{BSTx} - DRVHx = 100 mV		4	8	Ω
		Sink, V _{DRVHx} - LLx = 100 mV		1.5	4	
R _{DRVL}	DRVL resistance	Source, V _{VREG5} - DRVLx = 100 mV		4	8	Ω
		Sink, V _{DRVLx} = 100 mV		1.5	4	
T _D	Dead time	DRVHx-off to DRVLx-on		10		ns
		DRVLx-off to DRVHx-on		30		
Clock Output						
V _{CLKH}	High level voltage	I _{VCLK} = -10 mA, VO1 = 5 V, T _A = 25 °C	4.84	4.92		V
V _{CLKL}	Low level voltage	I _{VCLK} = 10 mA, VO1 = 5 V, T _A = 25 °C		0.06	0.12	
f _{CLK}	Clock frequency	T _A = 25 °C	175	270	325	kHz
Internal BST Diode						
V _{FBST}	Forward voltage	V _{VREG5-VBSTx} , I _F = 10 mA, T _A = 25 °C	0.7	0.8	0.9	V
I _{VBSTLK}	VBST leakage current	VBSTx = 34 V, LLx = 28 V, T _A = 25 °C		0.1	1	μA
Duty and Frequency Control						
T _{ON11}	CH1 on time 1	V _{IN} = 12 V, VO1 = 5 V, 200 kHz setting		2080		ns
T _{ON12}	CH1 on time 2	V _{IN} = 12 V, VO1 = 5 V, 245 kHz setting		1700		
T _{ON13}	CH1 on time 3	V _{IN} = 12 V, VO1 = 5 V, 300 kHz setting		1390		
T _{ON14}	CH1 on time 4	V _{IN} = 12 V, VO1 = 5 V, 365 kHz setting		1140		
T _{ON21}	CH2 on time 1	V _{IN} = 12 V, VO2 = 3.3 V, 250 kHz setting		1100		
T _{ON22}	CH2 on time 2	V _{IN} = 12 V, VO2 = 3.3 V, 305 kHz setting		900		
T _{ON23}	CH2 on time 3	V _{IN} = 12 V, VO2 = 3.3 V, 375 kHz setting		730		
T _{ON24}	CH2 on time 4	V _{IN} = 12 V, VO2 = 3.3 V, 460 kHz setting		600		
T _{ON(min)}	Minimum on time	T _A = 25 °C		80		
T _{OFF(min)}	Minimum off time	T _A = 25 °C		300		
Softstart						
T _{SS}	Internal SS time	Internal soft start	1.1	1.6	2.1	ms
Powergood						
V _{THPG}	PG threshold	PG in from lower	92.50%	95%	97.50%	
		PG in from higher	102.50%	105%	107.50%	
		PG hysteresis	2.50%	5%	7.50%	
I _{PGMAX}	PG sink current	PGOOD = 0.5 V	5	12		mA
T _{PGDEL}	PG delay	Delay for PG in	350	510	670	μs

ELECTRICAL CHARACTERISTICS (continued)

over operating free-air temperature range, VIN = 12 V (unless otherwise noted)

PARAMETER		CONDITIONS	MIN	TYP	MAX	UNIT
Logic Threshold and Setting Conditions						
V _{EN0}	EN0 setting voltage	Shutdown			0.4	V
		Enable, VCLK = off	0.8		1.6	
		Enable, VCLK = on	2.4			
I _{EN0}	EN0 current	V _{EN0} = 0.2 V	2	3.5	5	μA
		V _{EN0} = 1.5 V	1	1.75	2.5	
V _{EN}	ENTRIP1, ENTRIP2 threshold	Shutdown	350	400	450	mV
		Hysteresis	10	30	60	
V _{TONSEL}	TONSEL setting voltage	200 kHz/250 kHz			1.5	V
		245 kHz/305 kHz	1.9		2.1	
		300 kHz/375 kHz	2.7		3.6	
		365 kHz/460 kHz	4.7			
V _{SKIPSEL}	SKIPSEL setting voltage	PWM only			1.5	V
		Auto skip	1.9		2.1	
		OOA auto skip	2.7			
Protection: Current Sense						
I _{ENTRIP}	ENTRIPx source current	V _{ENTRIPx} = 920 mV, T _A = 25°C	9.4	10	10.6	μA
T _{CENTRIP}	ENTRIPx current temperature coefficient	On the basis of 25°C		4500		ppm/°C
V _{OCLoff}	OCP comparator offset	((V _{ENTRIPx-GND/9})-24 mV -V _{GND-LLx}) voltage, V _{ENTRIPx-GND} = 920 mV	-8	0	8	mV
V _{OCL(max)}	Maximum OCL setting	V _{ENTRIPx} = 5 V	185	205	225	
V _{ZC}	Zero cross detection comparator offset	V _{GND-LLx} voltage	-5	0	5	
V _{ENTRIP}	Current limit threshold	V _{ENTRIPx-GND} voltage, ⁽²⁾	0.515		2	V
Protection: UVP & OVP						
V _{OVP}	OVP trip threshold	OVP detect	110%	115%	120%	
T _{OVPDEL}	OVP prop delay			2		μs
V _{UVP}	Output UVP trip threshold	UVP detect	55%	60%	65%	
		Hysteresis		10%		
T _{UVPDEL}	Output UVP prop delay		20	32	40	μs
T _{UVPEN}	Output UVP enable delay		1.4	2	2.6	ms
UVLO						
V _{UVVREG5}	VREG5 UVLO threshold	Wake up	4.1	4.2	4.3	V
		Hysteresis	0.38	0.43	0.48	
V _{UVVREG3}	VREG3 UVLO threshold	Shutdown ⁽²⁾		VO2-1		
Thermal Shutdown						
T _{SDN}	Thermal shutdown threshold	Shutdown temperature ⁽²⁾		150		°C
		Hysteresis ⁽²⁾		10		

(2) Ensured by design. Not production tested.

DEVICE INFORMATION

Table 1. TERMINAL FUNCTIONS TABLE

TERMINAL		I/O	DESCRIPTION
NAME	NO.		
VIN	16	I	High voltage power supply input for 5-V/3.3-V LDO.
GND	15	-	Ground.
VREG3	8	O	3.3-V power supply output.
VREG5	17	O	5-V power supply output.
VREF	3	O	2-V reference voltage output.
EN0	13	I/O	Master enable input. Open : LDOs on, and ready to turn on VCLK and switcher channels. 620 k Ω to GND : enable both LDOs, VCLK off and ready to turn on switcher channels. Power consumption is almost the same as the case of VCLK = ON. 330 pF to 1 nF should be connected to GND near the device GND : disable all circuit
ENTRIP1, ENTRIP2	1, 6	I/O	Channel 1 and Channel 2 enable and OCL trip setting pins. Connect resistor from this pin to GND to set threshold for synchronous R _{DS(on)} sense. Short to ground to shutdown a switcher channel.
VO1, VO2	24, 7	I/O	Output connection to SMPS. These terminals work as fixed voltage inputs and output discharge inputs. VO1 and VO2 also work as 5 V and 3.3 V switch over return power input respectively.
VFB1, VFB2	2, 5	I	SMPS feedback inputs. Connect with feedback resistor divider.
PGOOD	23	O	Power Good window comparator output for channel 1 and 2. (Logical AND)
SKIPSEL	14	I	Selection pin for operation mode: OOA auto skip : Connect to VREG3 or VREG5 Auto skip : Connect to VREF PWM only : Connect to GND
TONSEL	4	I	On-time adjustment pin. 365 kHz/460 kHz setting : connect to VREG5 300 kHz/375 kHz setting : connect to VREG3 245 kHz/305 kHz setting : connect to VREF 200 kHz/250 kHz setting : connect to GND
DRVL1, DRVL2	19, 12	O	Low-side N-channel MOSFET driver outputs. GND referenced drivers.
VBST1, VBST2	22, 9	I	Supply input for high-side N-channel MOSFET driver (boost terminal).
DRVH1, DRVH2	21, 10	O	High-side N-channel MOSFET driver outputs. LL referenced drivers.
LL1, LL2	20, 11	I	Switch node connections for high-side drivers, current limit and control circuitry.
VCLK	18	O	270-kHz clock output for 15-V charge pump.

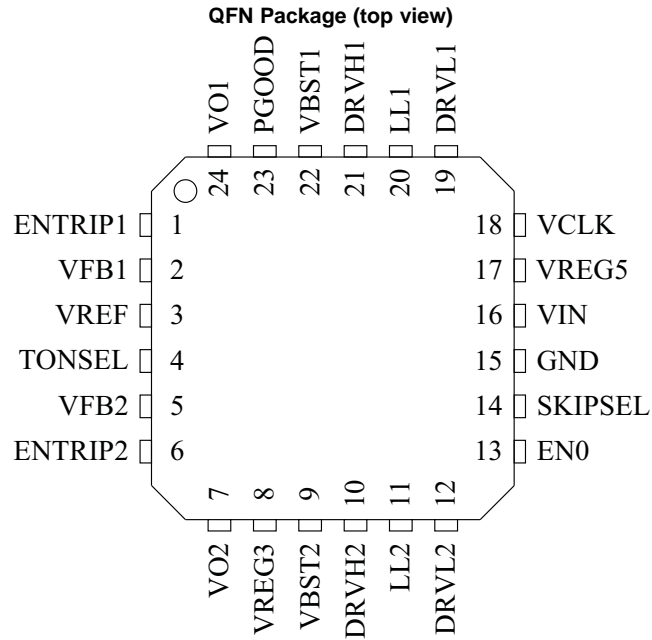

Functional Block Diagram

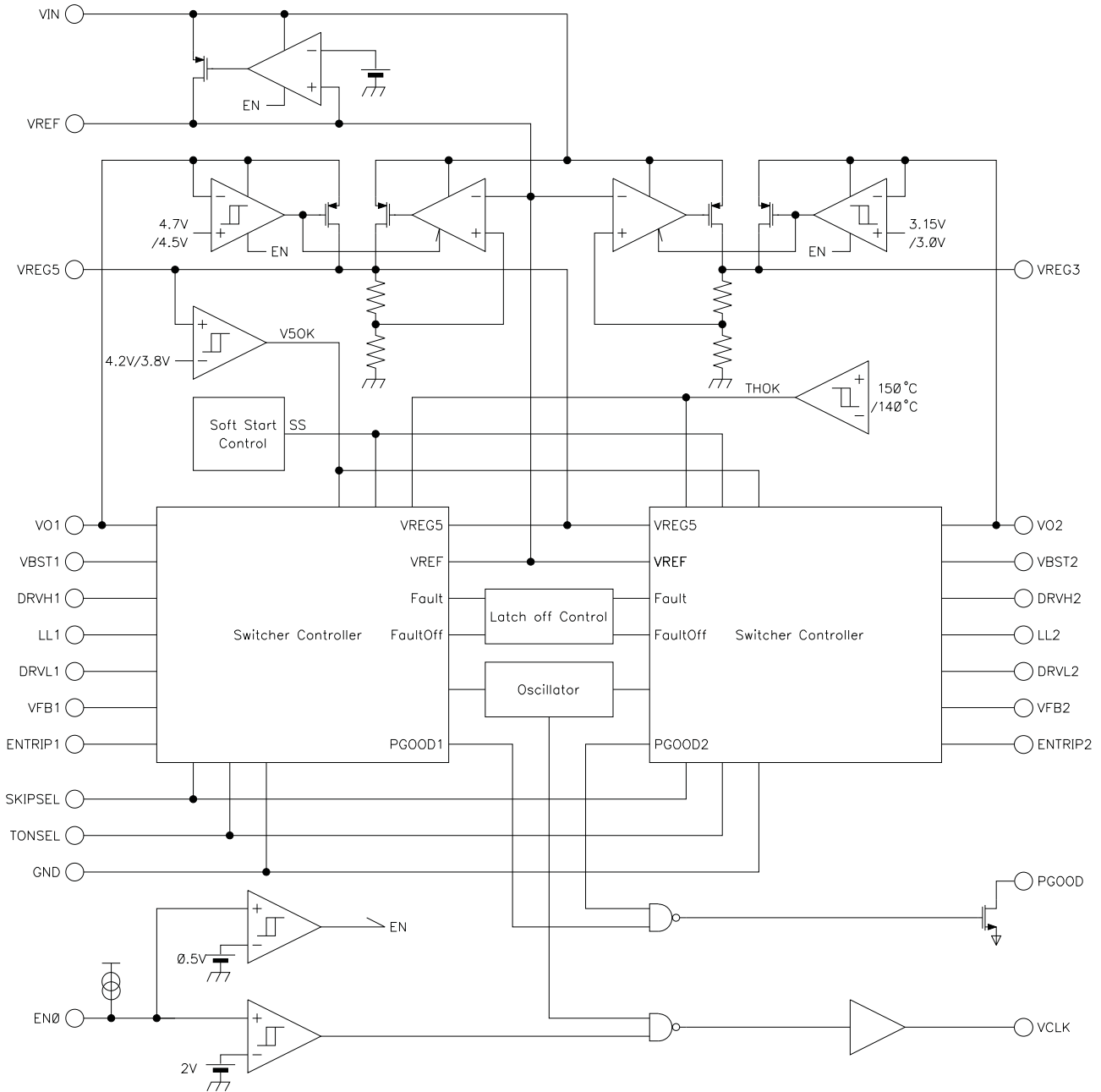

Switcher Controller Block

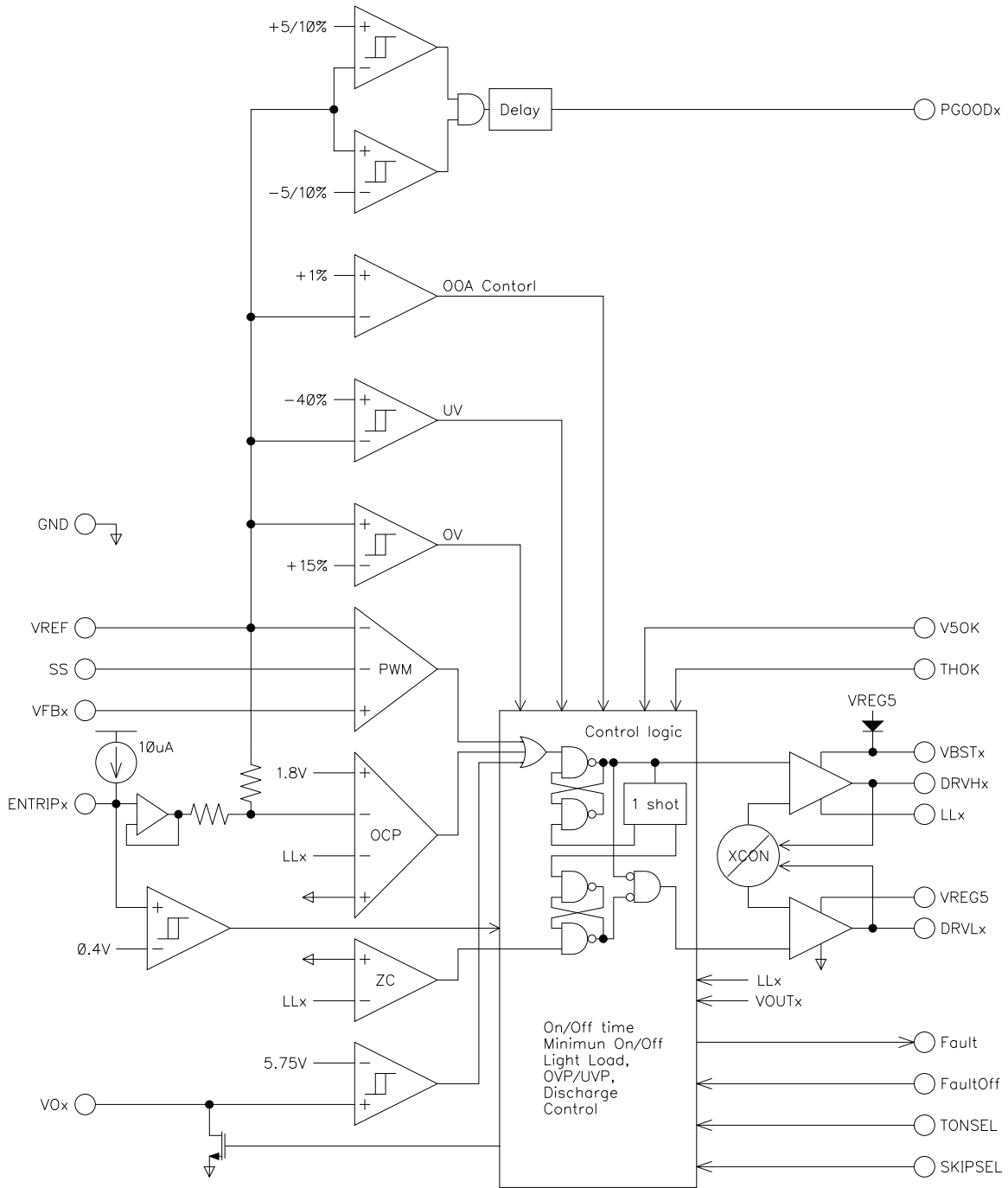

TYPICAL CHARACTERISTICS

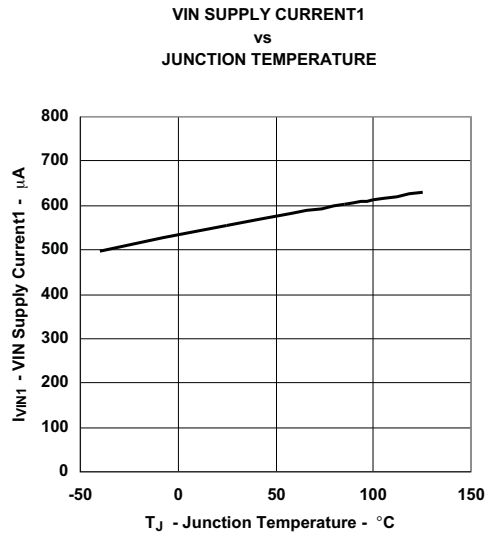

Figure 1.

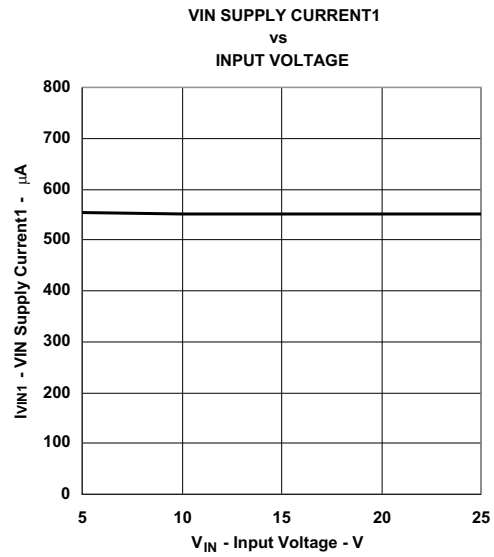

Figure 2.

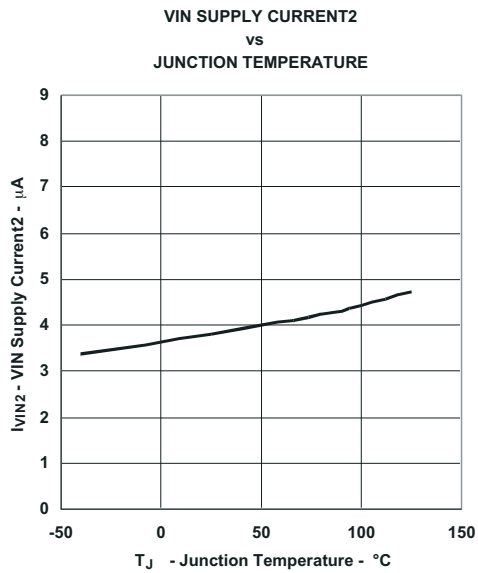

Figure 3.

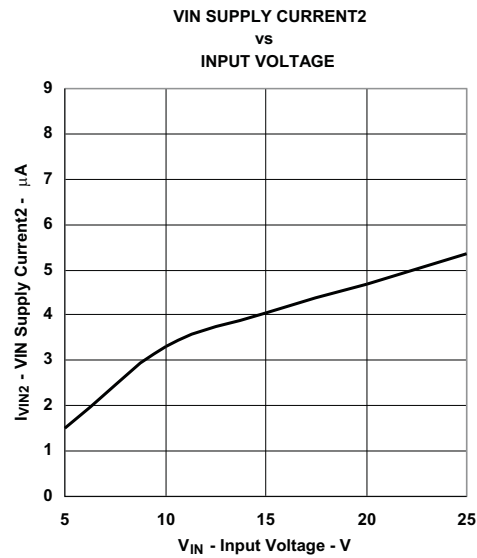

Figure 4.

TYPICAL CHARACTERISTICS (continued)

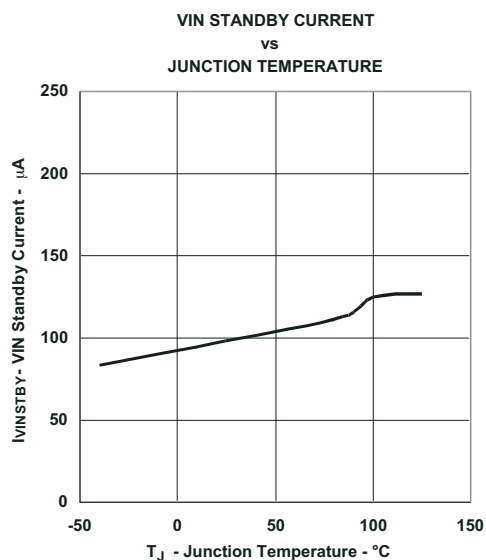

Figure 5.

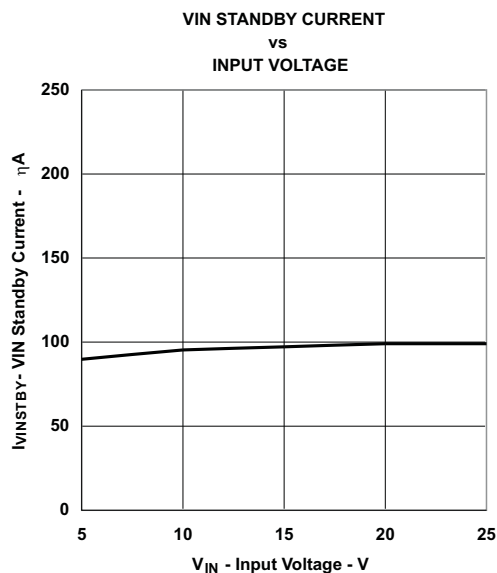

Figure 6.

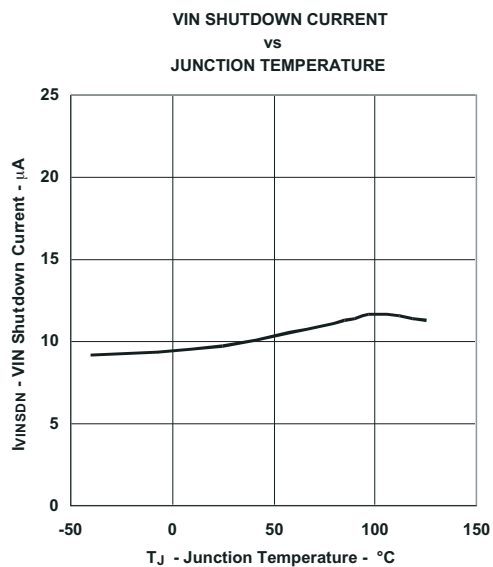

Figure 7.

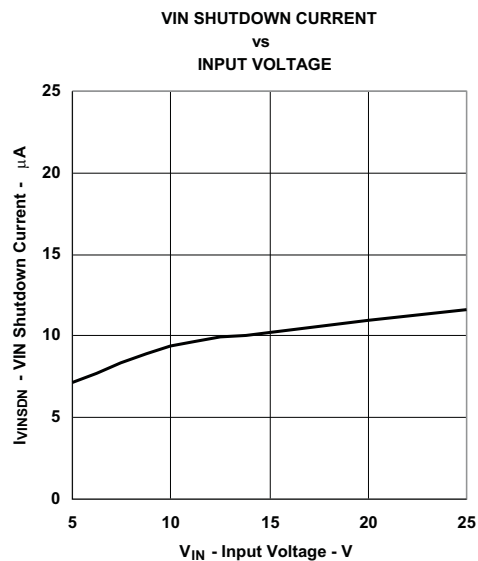

Figure 8.

TYPICAL CHARACTERISTICS (continued)

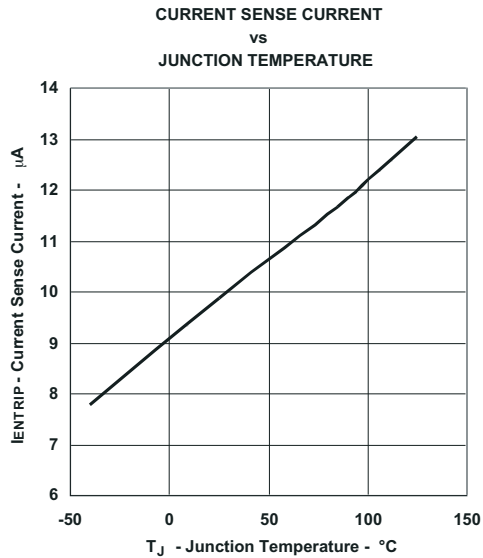

Figure 9.

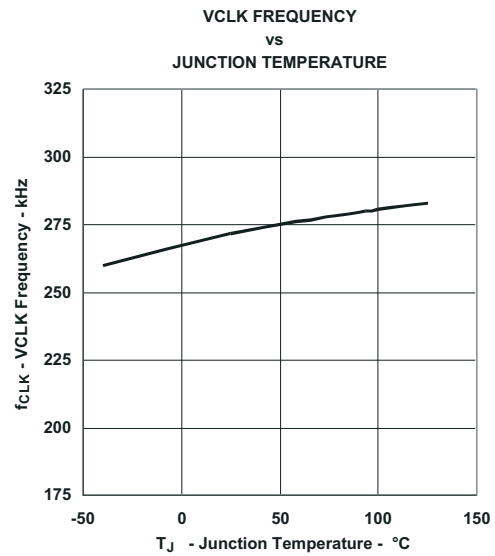

Figure 10.

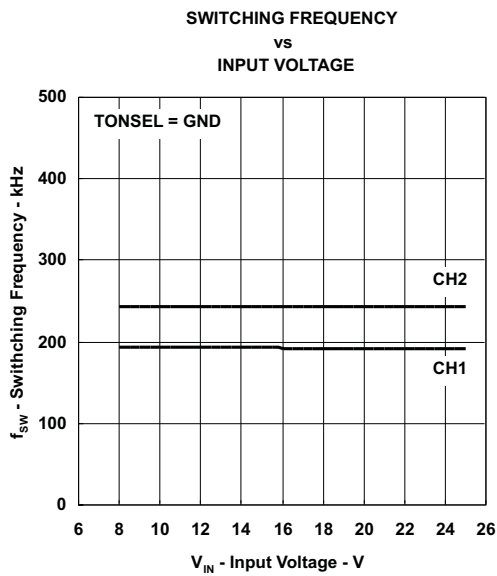

Figure 11.

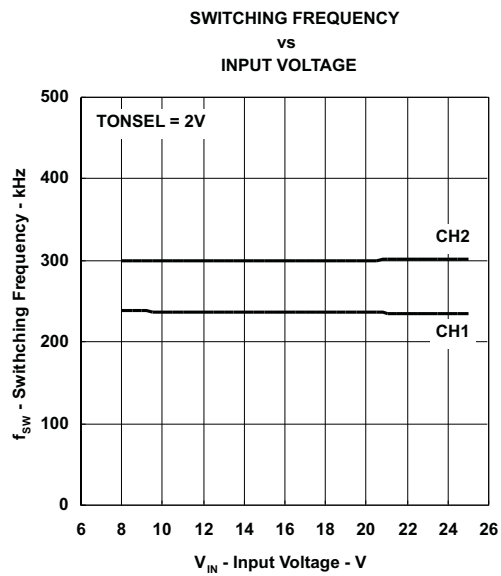

Figure 12.

TYPICAL CHARACTERISTICS (continued)

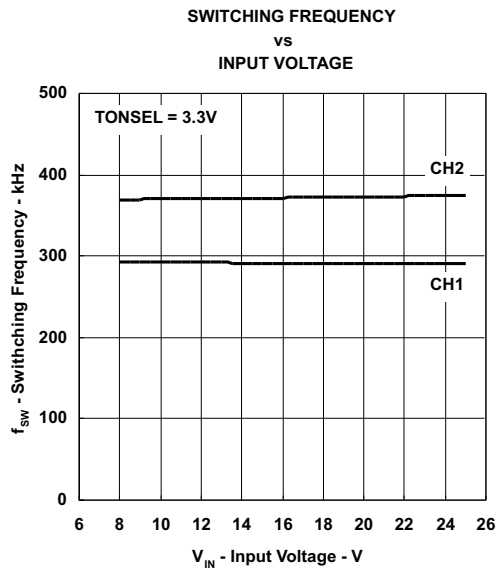

Figure 13.

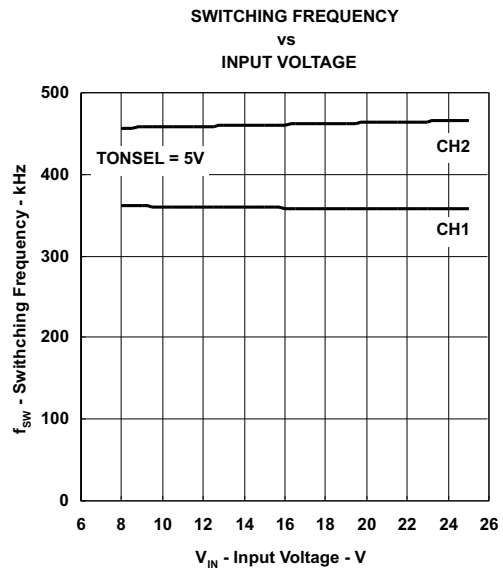

Figure 14.

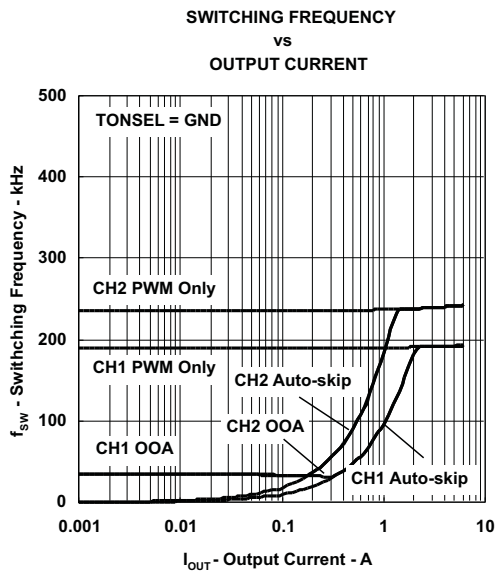

Figure 15.

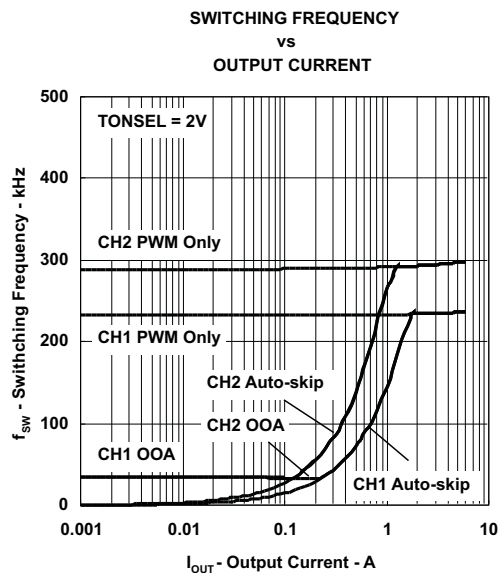

Figure 16.

TYPICAL CHARACTERISTICS (continued)

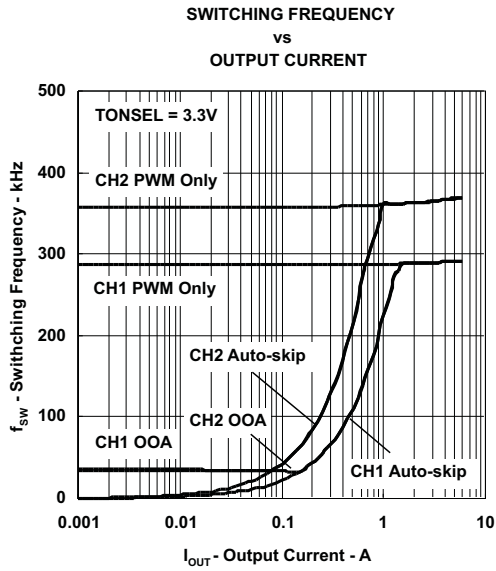

Figure 17.

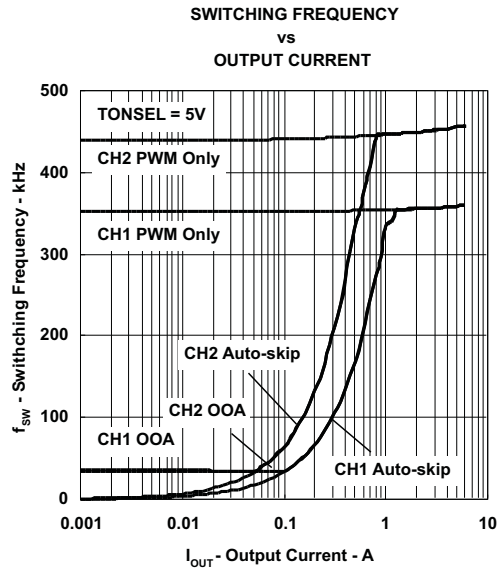

Figure 18.

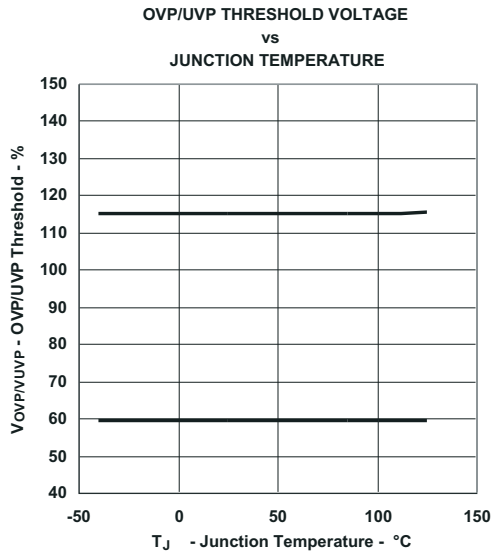

Figure 19.

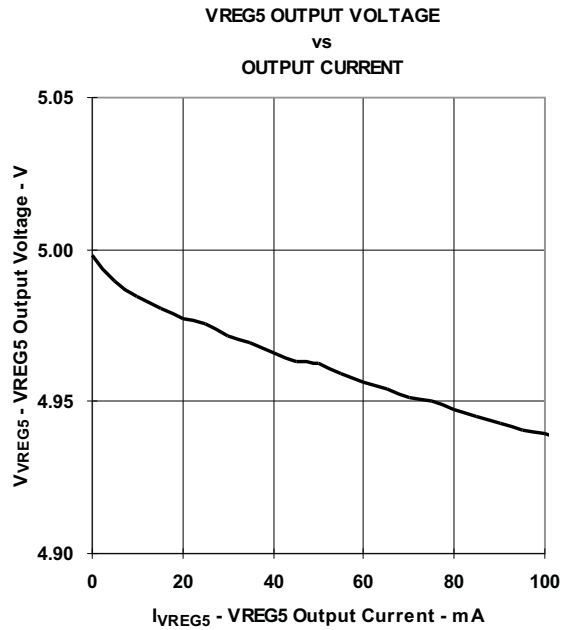

Figure 20.

TYPICAL CHARACTERISTICS (continued)

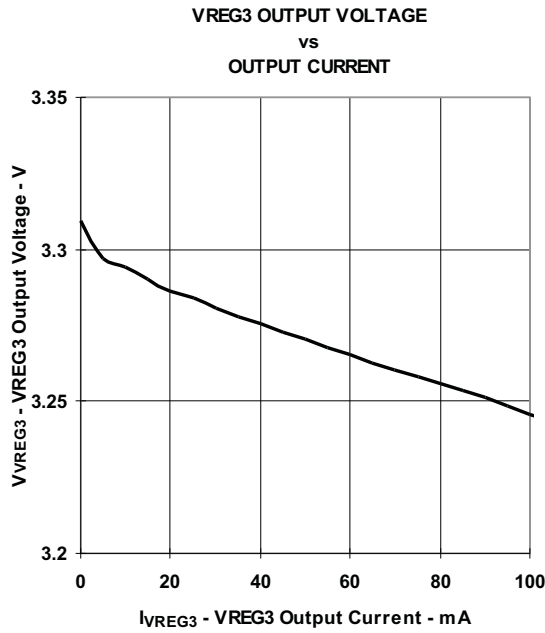

Figure 21.

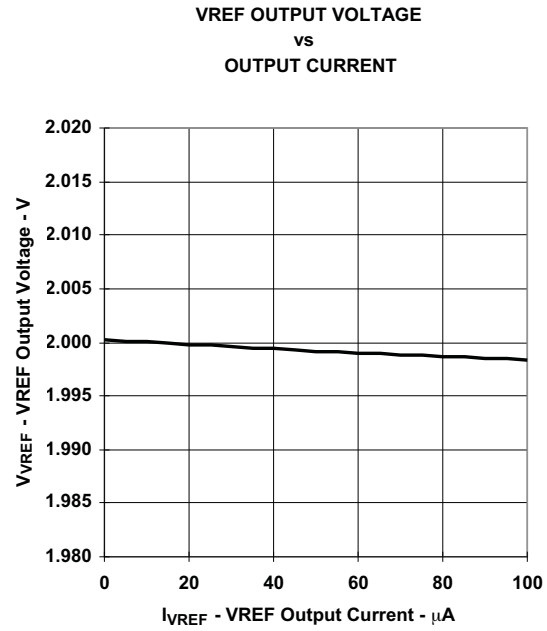

Figure 22.

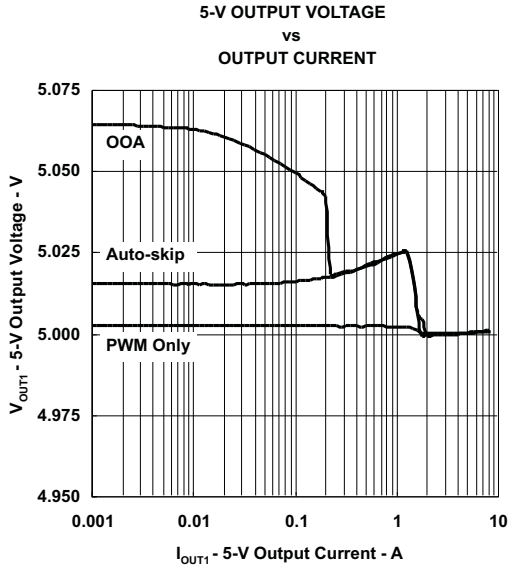

Figure 23.

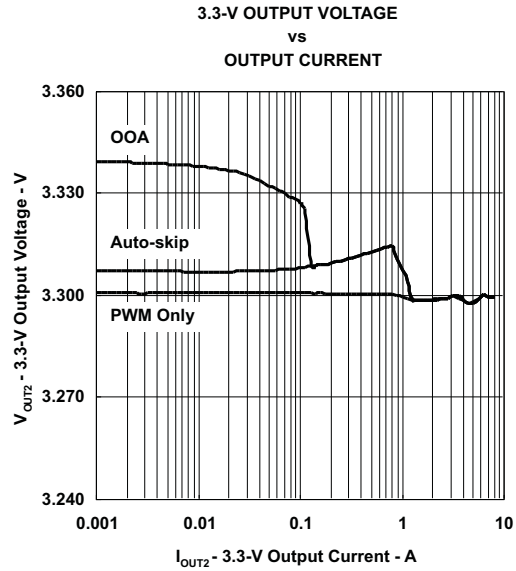

Figure 24.

TYPICAL CHARACTERISTICS (continued)

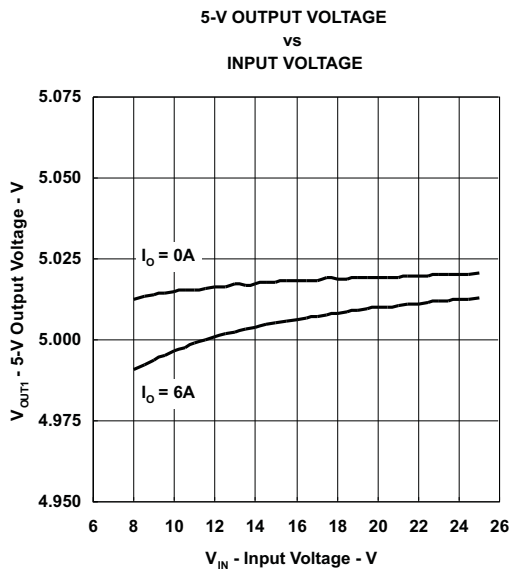

Figure 25.

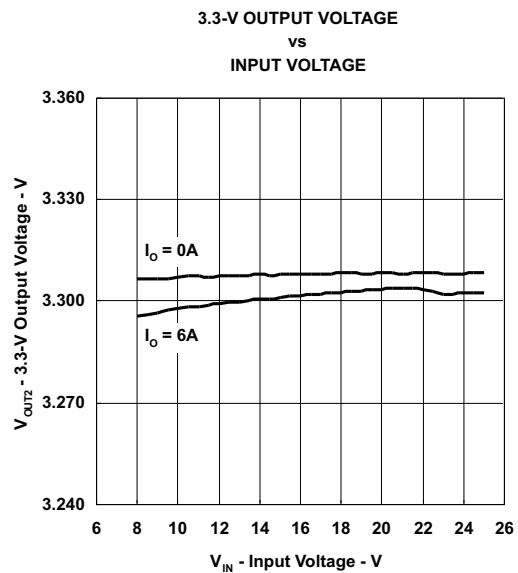

Figure 26.

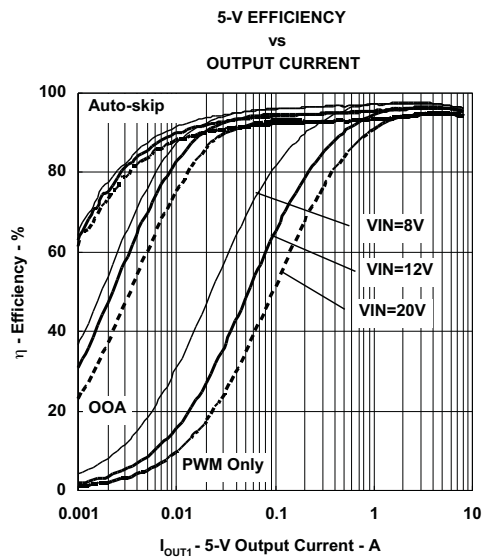

Figure 27.

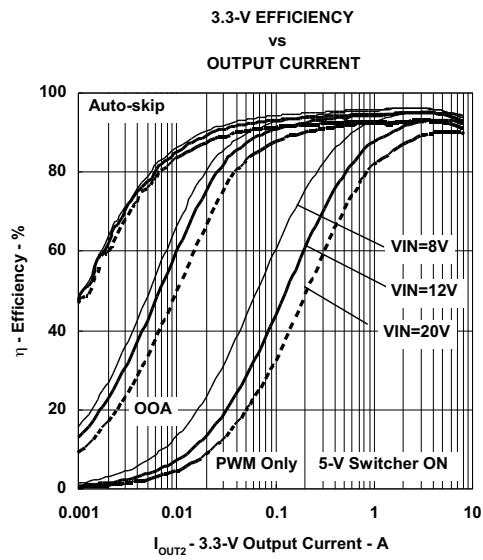

Figure 28.

TYPICAL CHARACTERISTICS (continued)

5-V Load Transient Response

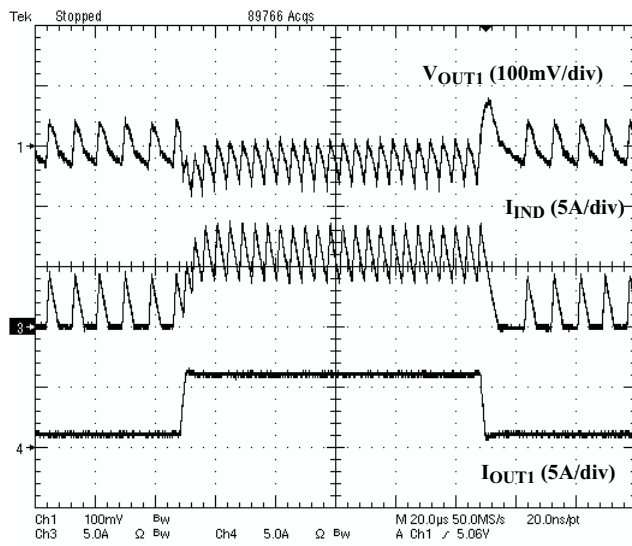

Figure 29.

3.3-V Load Transient Response

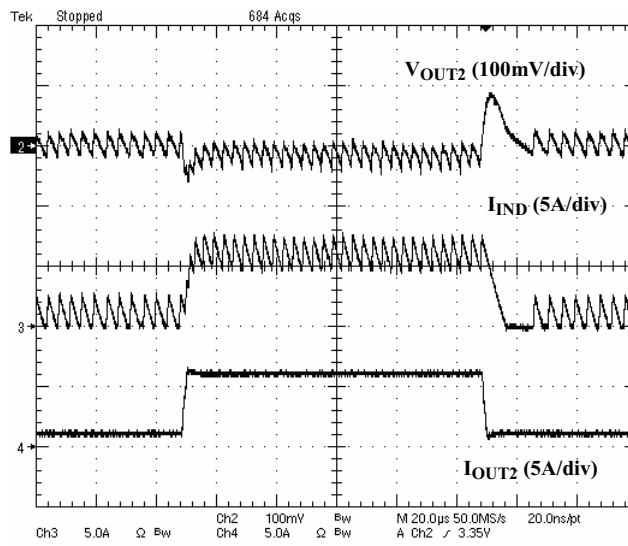

Figure 30.

5-V Startup Waveforms

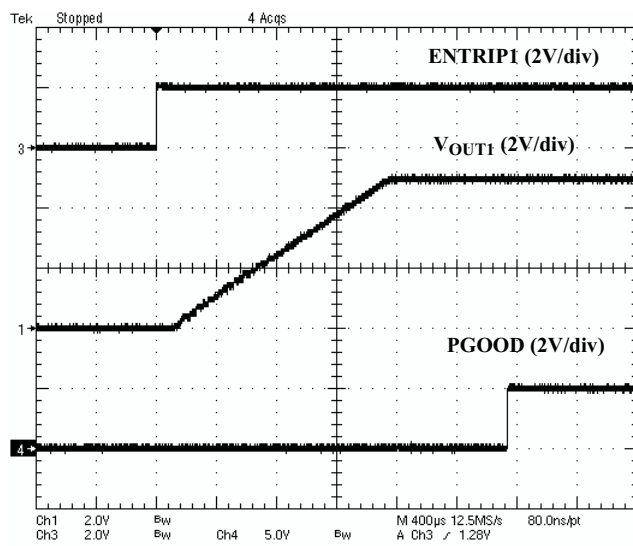

Figure 31.

3.3-V Startup Waveforms

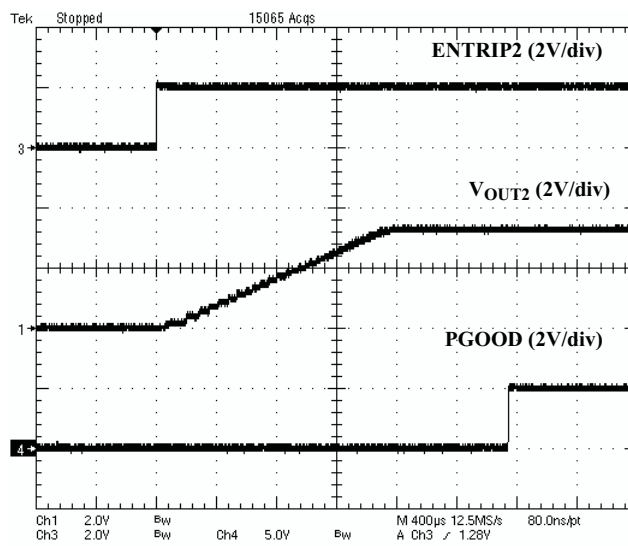

Figure 32.

TYPICAL CHARACTERISTICS (continued)

5-V Switchover Waveforms

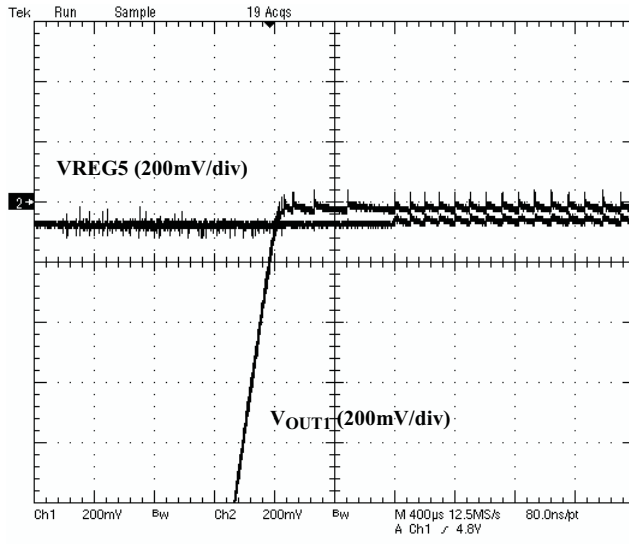

Figure 33.

3.3-V Switchover Waveforms

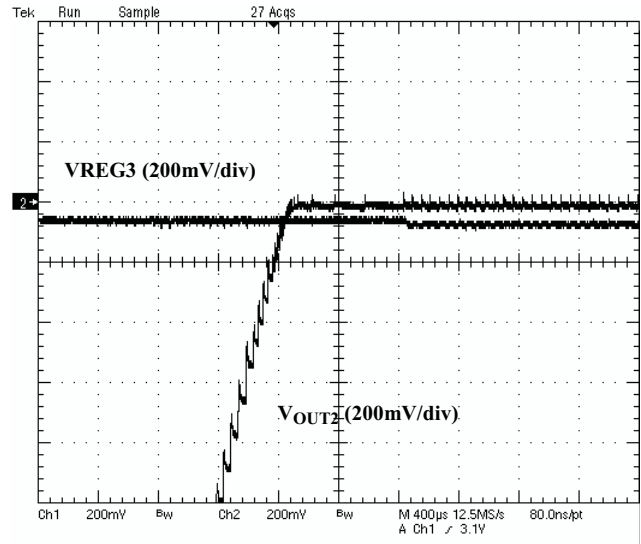

Figure 34.

5-V Soft-stop Waveforms

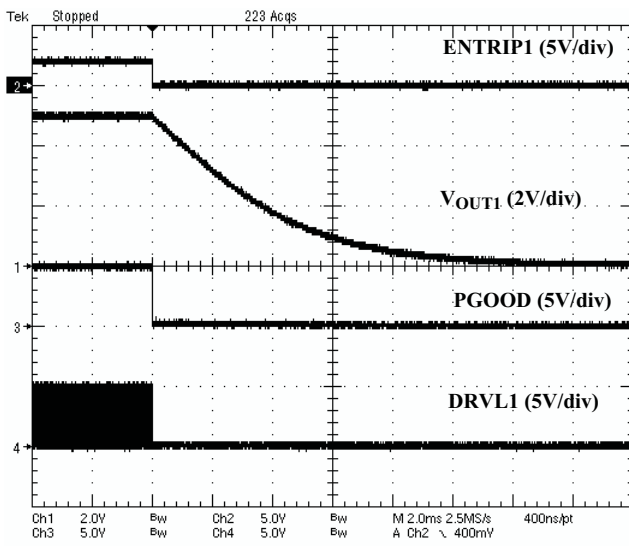

Figure 35.

3.3-V Soft-stop Waveforms

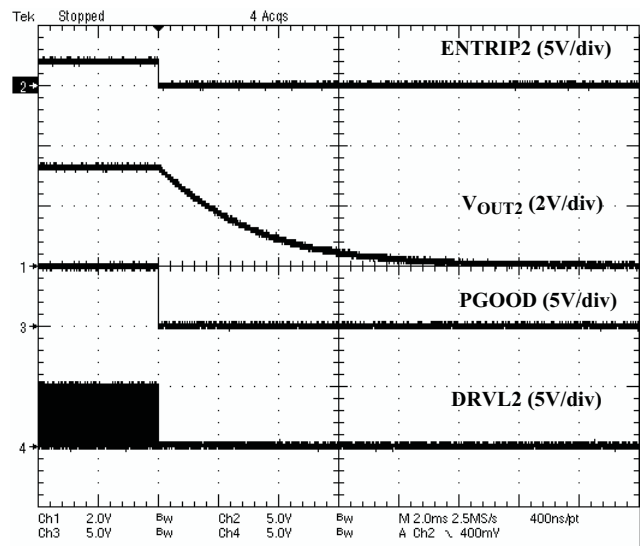

Figure 36.

APPLICATION INFORMATION

PWM Operations

The main control loop of the switch mode power supply (SMPS) is designed as an adaptive on-time pulse width modulation (PWM) controller. It supports a proprietary D-CAP™ mode. D-CAP™ mode does not require external compensation circuit and is suitable for low external component count configuration when used with appropriate amount of ESR at the output capacitor(s).

At the beginning of each cycle, the synchronous top MOSFET is turned on, or becomes 'ON' state. This MOSFET is turned off, or becomes 'OFF' state, after internal one shot timer expires. This one shot is determined by V_{IN} and V_{OUT} to keep frequency fairly constant over input voltage range, hence it is called adaptive on-time control. The MOSFET is turned on again when the feedback point voltage, V_{FB} , decreased to match with internal 2-V reference. The inductor current information is also monitored and should be below the over current threshold to initiate this new cycle. Repeating operation in this manner, the controller regulates the output voltage. The synchronous bottom or the "rectifying" MOSFET is turned on at the beginning of each 'OFF' state to keep the conduction loss minimum. The rectifying MOSFET is turned off before the top MOSFET turns on at next switching cycle or when inductor current information detects zero level. In the auto-skip mode or the OOA skip mode, this enables seamless transition to the reduced frequency operation at light load condition so that high efficiency is kept over broad range of load current.

Adaptive On-Time Control and PWM Frequency

TPS51125 does not have a dedicated oscillator on board. However, the part runs with pseudo-constant frequency by feed-forwarding the input and output voltage into the on-time, one-shot timer. The on-time is controlled inverse proportional to the input voltage and proportional to the output voltage so that the duty ratio will be kept as V_{OUT}/V_{IN} technically with the same cycle time. The frequencies are set by TONSEL terminal connection as [Table 2](#).

Table 2. TONSEL Connection and Switching Frequency

TONSEL CONNECTION	SWITCHING FREQUENCY	
	CH1	CH2
GND	200 kHz	250 kHz
VREF	245 kHz	305 kHz
VREG3	300 kHz	375 kHz
VREG5	365 kHz	460 kHz

Loop Compensation

From small-signal loop analysis, a buck converter using D-CAP™ mode can be simplified as below.

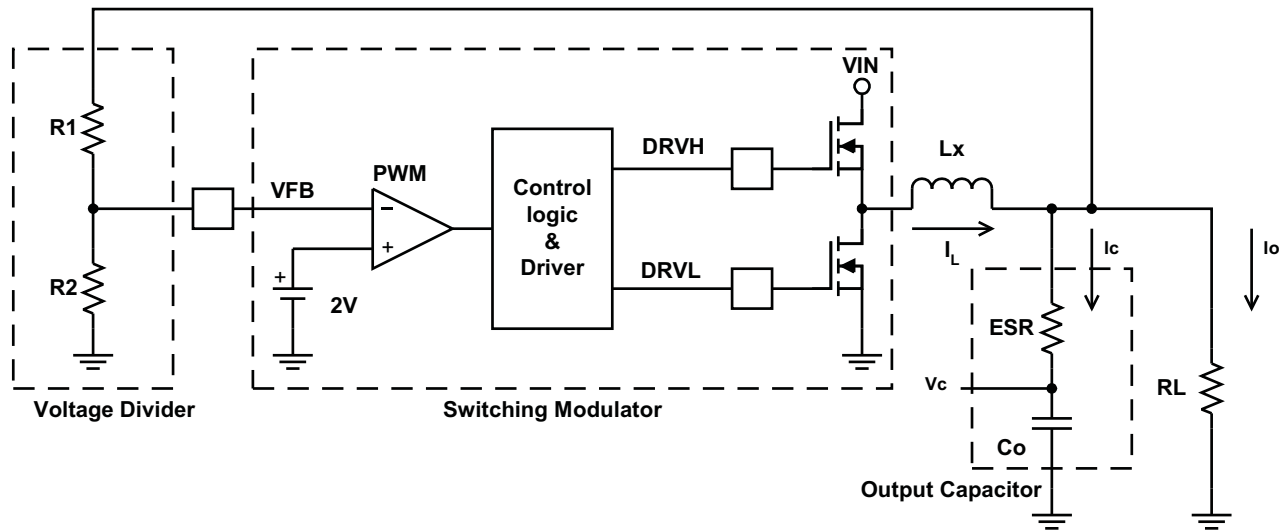

Figure 37. Simplifying the Modulator

The output voltage is compared with internal reference voltage after divider resistors, R1 and R2. The PWM comparator determines the timing to turn on high-side MOSFET. The gain and speed of the comparator is high enough to keep the voltage at the beginning of each on cycle substantially constant. For the loop stability, the 0dB frequency, f_0 , defined below need to be lower than 1/4 of the switching frequency.

$$f_0 = \frac{1}{2\pi \times ESR \times C_o} \leq \frac{f_{sw}}{4} \quad (1)$$

As f_0 is determined solely by the output capacitor's characteristics, loop stability of D-CAP™ mode is determined by the capacitor's chemistry. For example, specialty polymer capacitors (SP-CAP) have C_o in the order of several 100 μF and ESR in range of 10 m Ω . These will make f_0 in the order of 100 kHz or less and the loop will be stable. However, ceramic capacitors have f_0 at more than 700 kHz, which is not suitable for this operational mode.

Ramp Signal

The TPS51125 adds a ramp signal to the 2-V reference in order to improve its jitter performance. As described in the previous section, the feedback voltage is compared with the reference information to keep the output voltage in regulation. By adding a small ramp signal to the reference, the S/N ratio at the onset of a new switching cycle is improved. Therefore the operation becomes less jitter and stable. The ramp signal is controlled to start with -20mV at the beginning of ON-cycle and to become 0 mV at the end of OFF-cycle in steady state. By using this scheme, the TPS51125 improve jitter performance without sacrificing the reference accuracy.

Light Load Condition in Auto-Skip Operation

The TPS51125 automatically reduces switching frequency at light load conditions to maintain high efficiency. This reduction of frequency is achieved smoothly and without increase of V_{OUT} ripple. Detail operation is described as follows. As the output current decreases from heavy load condition, the inductor current is also reduced and eventually comes to the point that its 'valley' touches zero current, which is the boundary between continuous conduction and discontinuous conduction modes. The rectifying MOSFET is turned off when this zero inductor current is detected. As the load current further decreased, the converter runs in discontinuous conduction mode and it takes longer and longer to discharge the output capacitor to the level that requires next 'ON' cycle. The ON time is kept the same as that in the heavy load condition. In reverse, when the output current increase from light load to heavy load, switching frequency increases to the preset value as the inductor current reaches to the continuous conduction. The transition load point to the light load operation $I_{OUT(LL)}$ (i.e. the threshold between continuous and discontinuous conduction mode) can be calculated as follows;

$$I_{OUT(LL)} = \frac{1}{2 \times L \times f} \times \frac{(V_{IN} - V_{OUT}) \times V_{OUT}}{V_{IN}} \quad (2)$$

where f is the PWM switching frequency.

Switching frequency versus output current in the light load condition is a function of L , V_{IN} and V_{OUT} , but it decreases almost proportional to the output current from the $I_{OUT(LL)}$ given above. For example, it will be 60 kHz at $I_{OUT(LL)}/5$ if the frequency setting is 300 kHz.

Out-of-Audio™ Light-Load Operation

Out-of-Audio™ (OOA) light-load mode is a unique control feature that keeps the switching frequency above acoustic audible frequencies toward virtually no load condition while maintaining best of the art high conversion efficiency. When the Out-of-Audio™ operation is selected, OOA control circuit monitors the states of both MOSFET and force to change into the 'ON' state if both of MOSFETs are off for more than 32 μ s. This means that the top MOSFET is turned on even if the output voltage is higher than the target value so that the output capacitor is tends to be overcharged.

The OOA control circuit detects the over-voltage condition and begins to modulate the on time to keep the output voltage regulated. As a result, the output voltage becomes 0.5% higher than normal light-load operation.

Enable and Soft Start

EN0 is the control pin of VREG5, VREG3 and VREF regulators. Bring this node down to GND disables those three regulators and minimize the shutdown supply current to 10 μ A. Pulling this node up to 3.3 V or 5 V will turn the three regulators on to standby mode. The two switch mode power supplies (channel-1, channel-2) become ready to enable at this standby mode. The TPS51125 has an internal, 1.6 ms, voltage servo softstart for each channel. When the ENTRIPx pin becomes higher than the enable threshold voltage, which is typically 430 mV, an internal DAC begins ramping up the reference voltage to the PWM comparator. Smooth control of the output voltage is maintained during start up. As TPS51125 shares one DAC with both channels, if ENTRIPx pin becomes higher than the enable threshold voltage while another channel is starting up, soft start is postponed until another channel soft start has completed. If both of ENTRIP1 and ENTRIP2 become higher than the enable threshold voltage at a same time (within 60 μ s), both channels start up at same time.

Table 3. Enabling State

EN0	ENTRIP1	ENTRIP2	VREF	VREG5	VREG3	CH1	CH2	VCLK
GND	Don't Care	Don't Care	Off	Off	Off	Off	Off	Off
R to GND	Off	Off	On	On	On	Off	Off	Off
R to GND	On	Off	On	On	On	On	Off	Off
R to GND	Off	On	On	On	On	Off	On	Off
R to GND	On	On	On	On	On	On	On	Off
Open	Off	Off	On	On	On	Off	Off	Off
Open	On	Off	On	On	On	On	Off	On
Open	Off	On	On	On	On	Off	On	Off
Open	On	On	On	On	On	On	On	On

VREG5/VREG3 Linear Regulators

There are two sets of 100-mA standby linear regulators which outputs 5 V and 3.3 V, respectively. The VREG5 serves as the main power supply for the analog circuitry of the device and provides the current for gate drivers. The VREG3 is intended mainly for auxiliary 3.3-V supply for the notebook system during standby mode.

Add a ceramic capacitor with a value between 10 μ F and 22 μ F placed close to the VREG5 and VREG3 pins to stabilize LDOs.

VREG5 Switch Over

When the VO1 voltage becomes higher than 4.7 V AND channel-1 internal powergood flag is generated, internal 5-V LDO regulator is shut off and the VREG5 output is connected to VO1 by internal switch over MOSFET. The 510- μ s powergood delay helps a switch over without glitch.

VREG3 Switch Over

When the VO2 voltage becomes higher than 3.15 V AND channel-2 internal powergood flag is generated, internal 3.3-V LDO regulator is shut off and the VREG3 output is connected to VO2 by internal switch over MOSFET. The 510- μ s powergood delay helps a switch over without glitch.

Powergood

The TPS51125 has one powergood output that indicates 'high' when both switcher outputs are within the targets (AND gated). The powergood function is activated with 2-ms internal delay after ENTRIPx goes high. If the output voltage becomes within +/-5% of the target value, internal comparators detect power good state and the powergood signal becomes high after 510- μ s internal delay. Therefore PGOOD goes high around 2.5 ms after ENTRIPx goes high. If the output voltage goes outside of +/-10% of the target value, the powergood signal becomes low after 2- μ s internal delay. The powergood output is an open drain output and is needed to be pulled up outside.

Output Discharge Control

When ENTRIPx is low, the TPS51125 discharges outputs using internal MOSFET which is connected to VOx and GND. The current capability of these MOSFETs is limited to discharge slowly.

Low-Side Driver

The low-side driver is designed to drive high current low $R_{DS(on)}$ N-channel MOSFET(s). The drive capability is represented by its internal resistance, which are 4 Ω for VREG5 to DRVLx and 1.5 Ω for DRVLx to GND. A dead time to prevent shoot through is internally generated between top MOSFET off to bottom MOSFET on, and bottom MOSFET off to top MOSFET on. 5-V bias voltage is delivered from VREG5 supply. The instantaneous drive current is supplied by an input capacitor connected between VREG5 and GND. The average drive current is equal to the gate charge at $V_{gs} = 5$ V times switching frequency. This gate drive current as well as the high-side gate drive current times 5 V makes the driving power which need to be dissipated from TPS51125 package.

High-Side Driver

The high-side driver is designed to drive high current, low $R_{DS(on)}$ N-channel MOSFET(s). When configured as a floating driver, 5-V bias voltage is delivered from VREG5 supply. The average drive current is also calculated by the gate charge at $V_{gs} = 5$ V times switching frequency. The instantaneous drive current is supplied by the flying capacitor between VBSTx and LLx pins. The drive capability is represented by its internal resistance, which are 4 Ω for VBSTx to DRVHx and 1.5 Ω for DRVHx to LLx.

VCLK for Charge Pump

270-kHz clock signal can be used for charge pump circuit to generate approximately 15-V dc voltage. The clock signal becomes available when EN0 becomes higher than 2.4 V or open state. Note that the clock driver uses VO1 as its power supply. Regardless of enable or disable of VCLK, power consumption of the TPS51125 is almost the same. Therefore even if VCLK is not used, one can let EN0 pin open or supply logic 'high', as shown in Figure 38, and let VCLK pin open. This approach further reduces the external part count.

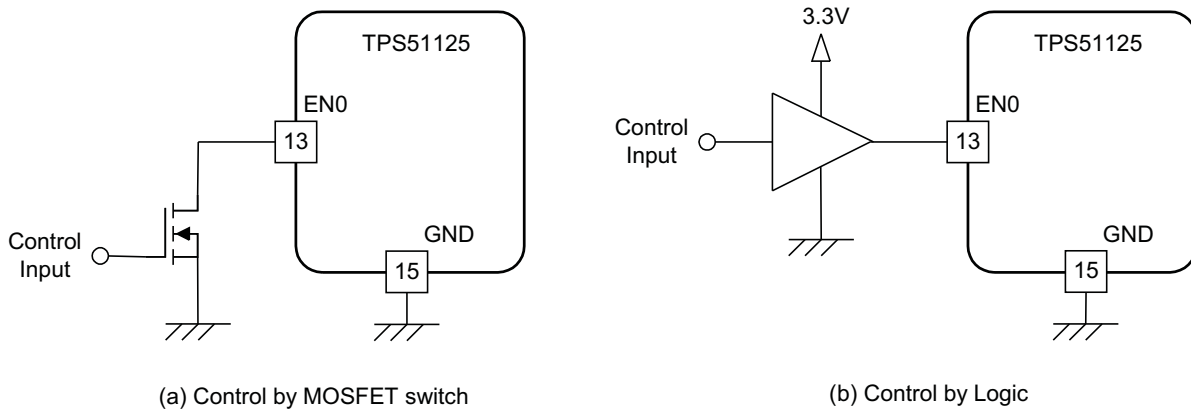

Figure 38. Control Example of EN0 Master Enable

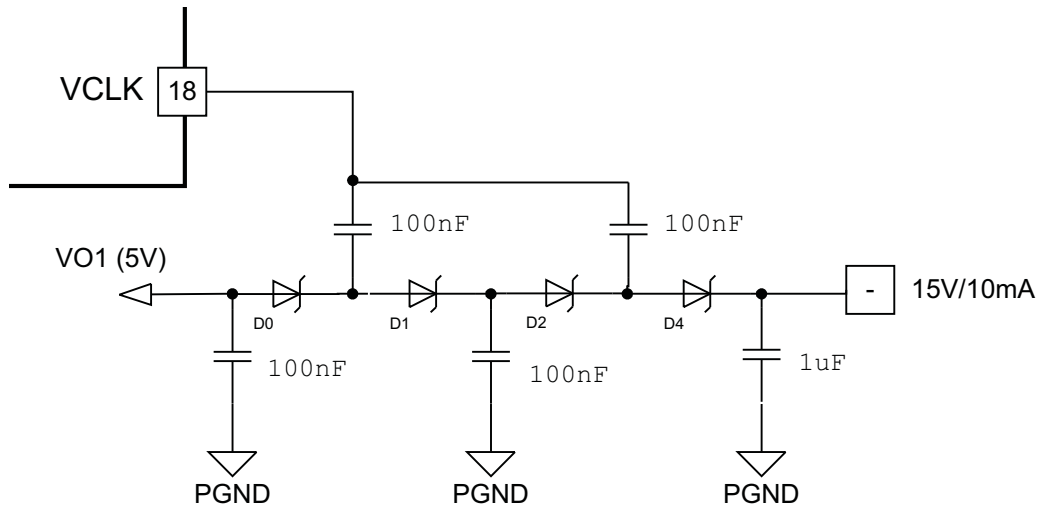

Figure 39. 15-V / 10-mA Charge Pump Configuration

Current Protection

TPS51125 has cycle-by-cycle over current limiting control. The inductor current is monitored during the 'OFF' state and the controller keeps the 'OFF' state during the inductor current is larger than the over current trip level. In order to provide both good accuracy and cost effective solution, TPS51125 supports temperature compensated MOSFET $R_{DS(on)}$ sensing. ENTRIPx pin should be connected to GND through the trip voltage setting resistor, R_{TRIP} . ENTRIPx terminal sources I_{TRIP} current, which is 10 μA typically at room temperature, and the trip level is set to the OCL trip voltage V_{TRIP} as below. Note that the V_{TRIP} is limited up to about 205 mV internally.

$$V_{trip}(mV) = \frac{R_{trip}(k\Omega) \times I_{trip}(\mu A)}{9} - 24(mV) \quad (3)$$

The inductor current is monitored by the voltage between GND pin and LLx pin so that LLx pin should be connected to the drain terminal of the bottom MOSFET properly. I_{trip} has 4500 ppm/ $^{\circ}C$ temperature slope to compensate the temperature dependency of the $R_{DS(on)}$. GND is used as the positive current sensing node so that GND should be connected to the proper current sensing device, i.e. the source terminal of the bottom MOSFET.

As the comparison is done during the 'OFF' state, V_{TRIP} sets valley level of the inductor current. Thus, the load current at over current threshold, I_{OCP} , can be calculated as follows;

$$I_{ocp} = V_{trip} / R_{dson} + I_{ripple} / 2 \quad (4)$$

$$= \frac{V_{trip}}{R_{dson}} + \frac{1}{2 \times L \times f} \times \frac{(V_{IN} - V_{OUT}) \times V_{OUT}}{V_{IN}} \quad (5)$$

In an over current condition, the current to the load exceeds the current to the output capacitor thus the output voltage tends to fall down. Eventually, it ends up with crossing the under voltage protection threshold and shutdown both channels.

Over/Under Voltage Protection

TPS51125 monitors a resistor divided feedback voltage to detect over and under voltage. When the feedback voltage becomes higher than 115% of the target voltage, the OVP comparator output goes high and the circuit latches as the top MOSFET driver OFF and the bottom MOSFET driver ON.

Also, TPS51125 monitors VOx voltage directly and if it becomes greater than 5.75 V the TPS51125 turns off the top MOSFET driver.

When the feedback voltage becomes lower than 60% of the target voltage, the UVP comparator output goes high and an internal UVP delay counter begins counting. After 32 μs , TPS51125 latches OFF both top and bottom MOSFETs drivers, and shut off both drivers of another channel. This function is enabled after 2 ms following ENTRIPx has become high.

UVLO Protection

TPS51125 has VREG5 under voltage lock out protection (UVLO). When the VREG5 voltage is lower than UVLO threshold voltage both switch mode power supplies are shut off. This is non-latch protection. When the VREG3 voltage is lower than (VO2 - 1 V), both switch mode power supplies are also shut off

Thermal Shutdown

TPS51125 monitors the temperature of itself. If the temperature exceeds the threshold value (typically 150°C), TPS51125 is shut off including LDOs. This is non-latch protection.

External Parts Selection

The external components selection is much simple in D-CAP™ Mode.

1. Determine the Value of R1 and R2

Recommended R2 value is from 10 kΩ to 20 kΩ. Determine R1 using equation as below.

$$R1 = \frac{(V_{out} - 2.0)}{2.0} \times R2 \quad (6)$$

2. Choose the Inductor

The inductance value should be determined to give the ripple current of approximately 1/4 to 1/2 of maximum output current. Larger ripple current increases output ripple voltage and improves S/N ratio and helps stable operation.

$$L = \frac{1}{I_{IND(ripple)} \times f} \times \frac{(V_{IN(max)} - V_{OUT}) \times V_{OUT}}{V_{IN(max)}} = \frac{3}{I_{OUT(max)} \times f} \times \frac{(V_{IN(max)} - V_{OUT}) \times V_{OUT}}{V_{IN(max)}} \quad (7)$$

The inductor also needs to have low DCR to achieve good efficiency, as well as enough room above peak inductor current before saturation. The peak inductor current can be estimated as follows.

$$I_{IND(peak)} = \frac{V_{trip}}{R_{DS(on)}} + \frac{1}{L \times f} \times \frac{(V_{IN(max)} - V_{OUT}) \times V_{OUT}}{V_{IN(max)}} \quad (8)$$

3. Choose the Output Capacitor(s)

Organic semiconductor capacitor(s) or specialty polymer capacitor(s) are recommended. Determine ESR to meet required ripple voltage above. A quick approximation is as shown in Equation 9. This equation is based on that required output ripple slope is approximately 20 mV per T_{SW} (switching period) in terms of VFB terminal voltage. D stands for duty factor.

$$ESR = \frac{V_{OUT} \times 20[mV] \times (1-D)}{2[V] \times I_{ripple}} = \frac{20[mV] \times L \times f}{2[V]} \quad (9)$$

Layout Considerations

Certain points must be considered before starting a layout work using the TPS51125.

- TPS51125 has only one GND pin and special care of GND trace design makes operation stable, especially when both channels operate. Group GND terminals of output voltage divider of both channels and the VREF capacitor as close as possible, connect them to an inner GND plane with PowerPad, overcurrent setting resistor, EN0 pull-down resistor and EN0 bypass capacitor as shown in the thin GND line of [Figure 40](#). This trace is named Signal Ground (SGND). Group ground terminals of VIN capacitor(s), VOUT capacitor(s) and source of low-side MOSFETs as close as possible, and connect them to another inner GND plane with GND pin of the device, GND terminal of VREG3 and VREG5 capacitors as shown in the bold GND line of [Figure 40](#). This trace is named Power Ground (PGND). SGND and 15-V charge-pump circuit should be connected to PGND at the middle point between ground terminal of VOUT capacitors.
- Inductor, VOUT capacitor(s), VIN capacitor(s) and MOSFETs are the power components and should be placed on one side of the PCB (solder side). Power components of each channel should be at the same distance from the TPS51125. Other small signal parts should be placed on another side (component side). Inner GND planes above should shield and isolate the small signal traces from noisy power lines.
- PCB trace defined as LLx node, which connects to source of high-side MOSFET, drain of low-side MOSFET and high-voltage side of the inductor, should be as short and wide as possible.
- VREG5 and VREG3 require at least 10- μ F, VREF requires a 220-nF ceramic bypass capacitor which should be placed close to the device and traces should be no longer than 10 mm.
- Connect the overcurrent setting resistors from ENTRIPx to SGND and close to the device, right next to the device if possible.
- The discharge path (VOx) should have a dedicated trace to the output capacitor; separate from the output voltage sensing trace. When LDO5 is switched over Vo1 trace should be 1.5 mm with no loops. When LDO3 is switched over and loaded Vo2 trace should also be 1.5 mm with no loops. There is no restriction for just monitoring Vox. Make the feedback current setting resistor (the resistor between VFBx to SGND close to the device. Place on the component side and avoid vias between this resistor and the device.
- Connections from the drivers to the respective gate of the high-side or the low-side MOSFET should be as short as possible to reduce stray inductance. Use 0.65-mm (25 mils) or wider trace and via(s) of at least 0.5 mm (20 mils) diameter along this trace.
- All sensitive analog traces and components such as VOx, VFBx, VREF, GND, EN0, ENTRIPx, PGOOD, TONSEL and SKIPSEL should be placed away from high-voltage switching nodes such as LLx, DRVLx, DRVHx and VCLK nodes to avoid coupling. Connect 330-pF to 1-nF ceramic bypass capacitor to EN0 in parallel with 620-k Ω resistor when VCLK is disabled.
- Traces for VFB1 and VFB2 should be short and laid apart each other to avoid channel to channel interference.
- In order to effectively remove heat from the package, prepare thermal land and solder to the package's thermal pad. Three by three or more vias with a 0.33-mm (13 mils) diameter connected from the thermal land to the internal ground plane should be used to help dissipation. This thermal land underneath the package should be connected to SGND, and should NOT be connected to PGND.

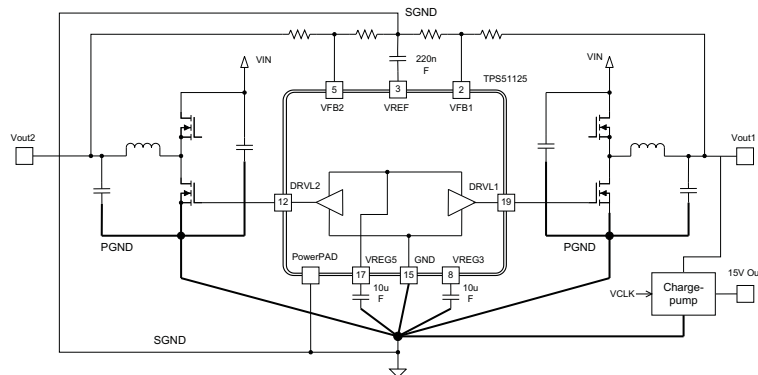
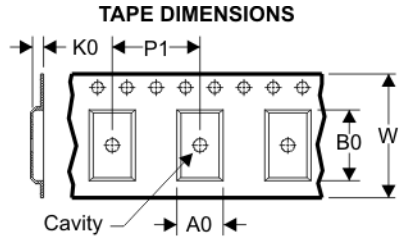
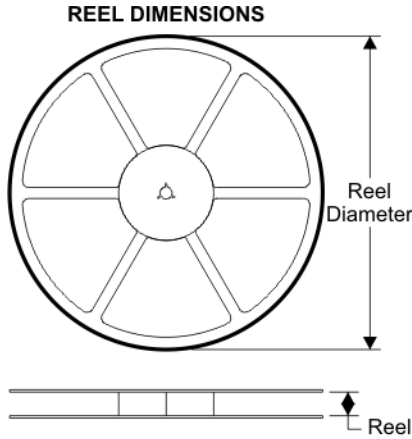

Figure 40. GND system of DC/DC converter using the TPS51125

TAPE AND REEL BOX INFORMATION



A0	Dimension designed to accommodate the component width
B0	Dimension designed to accommodate the component length
K0	Dimension designed to accommodate the component thickness
W	Overall width of the carrier tape
P1	Pitch between successive cavity centers

QUADRANT ASSIGNMENTS FOR PIN 1 ORIENTATION IN TAPE

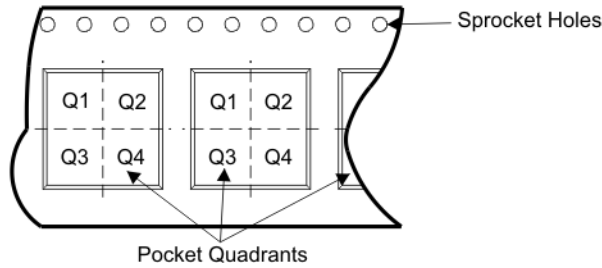

Device	Package	Pins	Site	Reel Diameter (mm)	Reel Width (mm)	A0 (mm)	B0 (mm)	K0 (mm)	P1 (mm)	W (mm)	Pin1 Quadrant
TPS51125RGER	RGE	24	SITE 41	330	12	4.3	4.3	1.5	8	12	Q2
TPS51125RGET	RGE	24	SITE 41	180	12	4.3	4.3	1.5	8	12	Q2

TAPE AND REEL BOX DIMENSIONS



Device	Package	Pins	Site	Length (mm)	Width (mm)	Height (mm)
TPS51125RGER	RGE	24	SITE 41	346.0	346.0	29.0
TPS51125RGET	RGE	24	SITE 41	190.0	212.7	31.75

RGE (S-PQFP-N24) PIN 1 OPTION PLASTIC QUAD FLATPACK

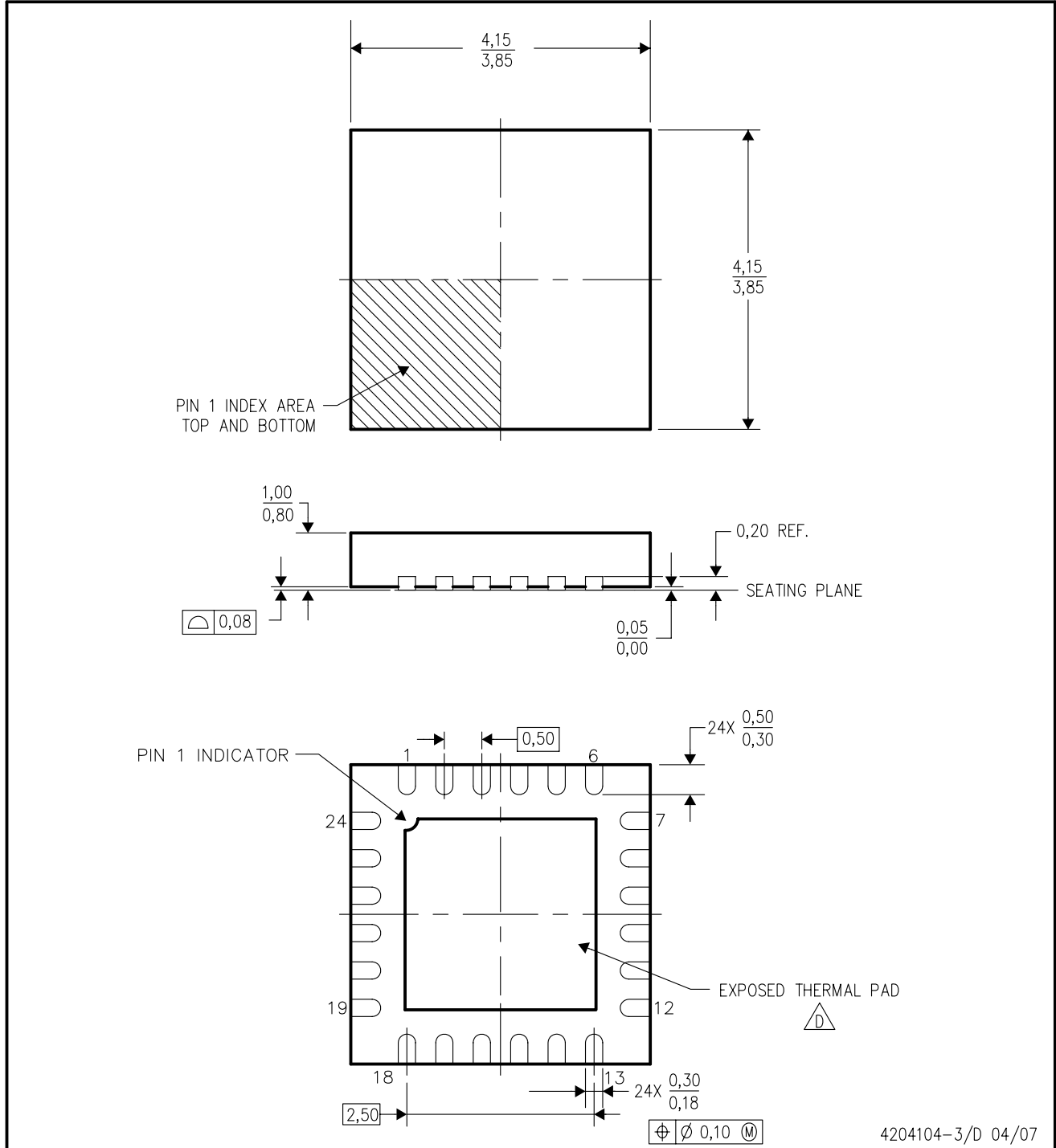

- NOTES:
- A. All linear dimensions are in millimeters. Dimensioning and tolerancing per ASME Y14.5M-1994.
 - B. This drawing is subject to change without notice.
 - C. Quad Flatpack, No-Leads (QFN) package configuration.
 - D. The package thermal pad must be soldered to the board for thermal and mechanical performance. See the Product Data Sheet for details regarding the exposed thermal pad dimensions.
 - E. Falls within JEDEC MO-220.

THERMAL INFORMATION

This package incorporates an exposed thermal pad that is designed to be attached directly to an external heatsink. The thermal pad must be soldered directly to the printed circuit board (PCB). After soldering, the PCB can be used as a heatsink. In addition, through the use of thermal vias, the thermal pad can be attached directly to the appropriate copper plane shown in the electrical schematic for the device, or alternatively, can be attached to a special heatsink structure designed into the PCB. This design optimizes the heat transfer from the integrated circuit (IC).

For information on the Quad Flatpack No-Lead (QFN) package and its advantages, refer to Application Report, Quad Flatpack No-Lead Logic Packages, Texas Instruments Literature No. SCBA017. This document is available at www.ti.com.

The exposed thermal pad dimensions for this package are shown in the following illustration.

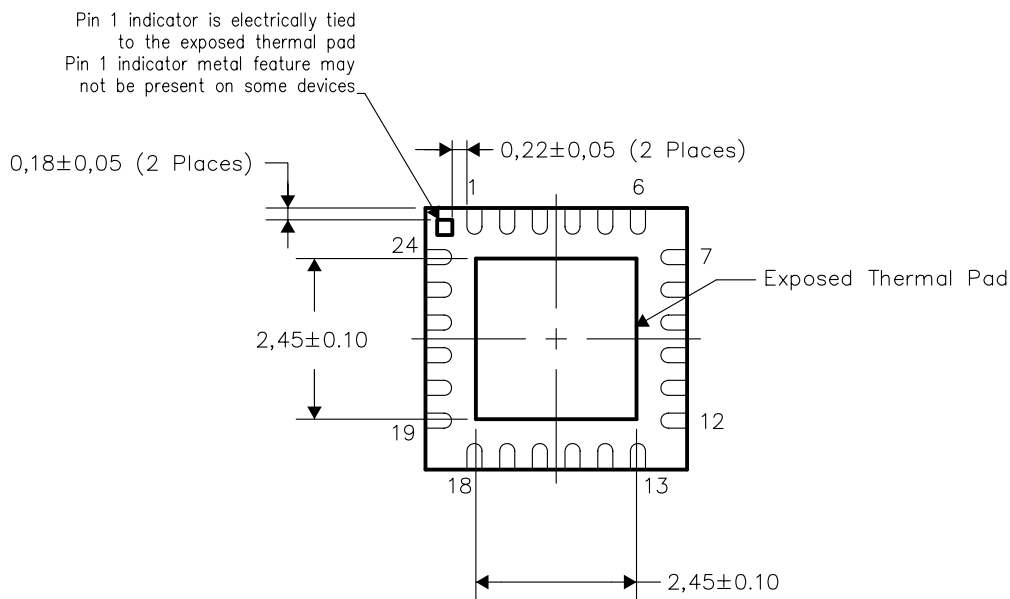

Bottom View

NOTE: All linear dimensions are in millimeters

Exposed Thermal Pad Dimensions

RGE (S-PQFP-N24)

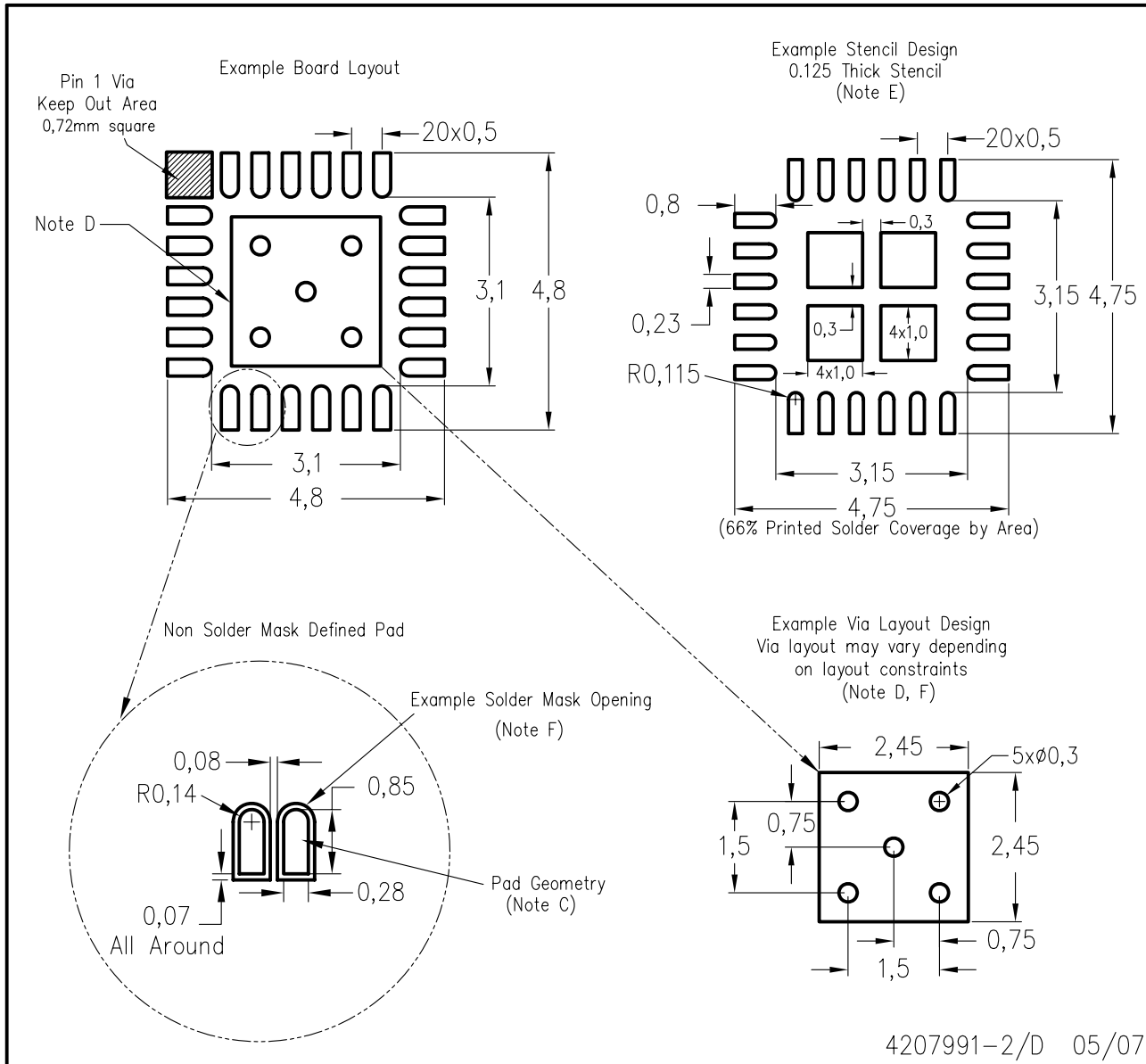

- NOTES:
- A. All linear dimensions are in millimeters.
 - B. This drawing is subject to change without notice.
 - C. Publication IPC-7351 is recommended for alternate designs.
 - D. This package is designed to be soldered to a thermal pad on the board. Refer to Application Note, Quad Flat-Pack Packages, Texas Instruments Literature No. SCBA017, SLUA271, and also the Product Data Sheets for specific thermal information, via requirements, and recommended board layout. These documents are available at www.ti.com <<http://www.ti.com>>.
 - E. Laser cutting apertures with trapezoidal walls and also rounding corners will offer better paste release. Customers should contact their board assembly site for stencil design recommendations. Refer to IPC 7525 for stencil design considerations.
 - F. Customers should contact their board fabrication site for recommended solder mask tolerances and via tenting recommendations for vias placed in the thermal pad.

IMPORTANT NOTICE

Texas Instruments Incorporated and its subsidiaries (TI) reserve the right to make corrections, modifications, enhancements, improvements, and other changes to its products and services at any time and to discontinue any product or service without notice. Customers should obtain the latest relevant information before placing orders and should verify that such information is current and complete. All products are sold subject to TI's terms and conditions of sale supplied at the time of order acknowledgment.

TI warrants performance of its hardware products to the specifications applicable at the time of sale in accordance with TI's standard warranty. Testing and other quality control techniques are used to the extent TI deems necessary to support this warranty. Except where mandated by government requirements, testing of all parameters of each product is not necessarily performed.

TI assumes no liability for applications assistance or customer product design. Customers are responsible for their products and applications using TI components. To minimize the risks associated with customer products and applications, customers should provide adequate design and operating safeguards.

TI does not warrant or represent that any license, either express or implied, is granted under any TI patent right, copyright, mask work right, or other TI intellectual property right relating to any combination, machine, or process in which TI products or services are used. Information published by TI regarding third-party products or services does not constitute a license from TI to use such products or services or a warranty or endorsement thereof. Use of such information may require a license from a third party under the patents or other intellectual property of the third party, or a license from TI under the patents or other intellectual property of TI.

Reproduction of TI information in TI data books or data sheets is permissible only if reproduction is without alteration and is accompanied by all associated warranties, conditions, limitations, and notices. Reproduction of this information with alteration is an unfair and deceptive business practice. TI is not responsible or liable for such altered documentation. Information of third parties may be subject to additional restrictions.

Resale of TI products or services with statements different from or beyond the parameters stated by TI for that product or service voids all express and any implied warranties for the associated TI product or service and is an unfair and deceptive business practice. TI is not responsible or liable for any such statements.

TI products are not authorized for use in safety-critical applications (such as life support) where a failure of the TI product would reasonably be expected to cause severe personal injury or death, unless officers of the parties have executed an agreement specifically governing such use. Buyers represent that they have all necessary expertise in the safety and regulatory ramifications of their applications, and acknowledge and agree that they are solely responsible for all legal, regulatory and safety-related requirements concerning their products and any use of TI products in such safety-critical applications, notwithstanding any applications-related information or support that may be provided by TI. Further, Buyers must fully indemnify TI and its representatives against any damages arising out of the use of TI products in such safety-critical applications.

TI products are neither designed nor intended for use in military/aerospace applications or environments unless the TI products are specifically designated by TI as military-grade or "enhanced plastic." Only products designated by TI as military-grade meet military specifications. Buyers acknowledge and agree that any such use of TI products which TI has not designated as military-grade is solely at the Buyer's risk, and that they are solely responsible for compliance with all legal and regulatory requirements in connection with such use.

TI products are neither designed nor intended for use in automotive applications or environments unless the specific TI products are designated by TI as compliant with ISO/TS 16949 requirements. Buyers acknowledge and agree that, if they use any non-designated products in automotive applications, TI will not be responsible for any failure to meet such requirements.

Following are URLs where you can obtain information on other Texas Instruments products and application solutions:

Products		Applications	
Amplifiers	amplifier.ti.com	Audio	www.ti.com/audio
Data Converters	dataconverter.ti.com	Automotive	www.ti.com/automotive
DSP	dsp.ti.com	Broadband	www.ti.com/broadband
Interface	interface.ti.com	Digital Control	www.ti.com/digitalcontrol
Logic	logic.ti.com	Military	www.ti.com/military
Power Mgmt	power.ti.com	Optical Networking	www.ti.com/opticalnetwork
Microcontrollers	microcontroller.ti.com	Security	www.ti.com/security
RFID	www.ti-rfid.com	Telephony	www.ti.com/telephony
Low Power Wireless	www.ti.com/lpw	Video & Imaging	www.ti.com/video
		Wireless	www.ti.com/wireless

Mailing Address: Texas Instruments, Post Office Box 655303, Dallas, Texas 75265
Copyright © 2007, Texas Instruments Incorporated